



DL4 AND DL6 | CCT ADJUSTABLE DOWNLIGHT

Project: _____ Type: _____

Name: _____ Date: _____



OVERVIEW

- Tunable:** Adjustable CCT
- Applications:** Indoor IP24
- Efficacy:** 75-80lm/W
- Dimming:** TRIAC
- LED Type:** SMD2835
- Operating Temp:** -4°F to 122°F
- Lifespan:** 50,000 hours
- Warranty:** 5 years
- Quantity:** 40 units/Case
2 units/Box

Size	4": 5.1" x 5.1" x 2.3" 6": 7.4" x 7.4" x 2.4"
Watts	15W
Voltage	AC120V (50/60Hz)
Dimming	TRIAC
Beam Angle	100°
CRI	≥90
PF	≥ 0.7

Lumens	4": ± 750lm 6": ± 1,200lm
CCT	2700K + 3000K + 3500 4000K + 5000K
IP Rating	IP24
Materials	Aluminum, PC
Finish	White
Lens	Frosted
Lifespan	50,000 Hours

FEATURES

- Flicker Free
- LED Adjustable CCT Downlights are safe for indoor locations such as living rooms, dining rooms, bedrooms, etc.
- CRI of 90 renders light temperature consistently in various environments, giving colors true clarity
- These lights are intended only for indoor use
- LED Adjustable CCT Downlights are perfect for homes, schools, offices and hotels
- Noiseless
- Extra long lifetime
- Instant-on lighting

SARIN LED Adjustable CCT Downlights are commonly used in spaces with high ceilings like hotels, living spaces, schools, and offices. These ceiling lights are safe for indoor use.

Extremely easy to install, this powerful recessed Downlight is equipped with a quick-connect case, E26 retrofit plug, and conduit to integrate with an existing fixture frame junction box.

This light is dimmable to 10%. Get comfortable, diffused light with no flickering.





DL4 AND DL6 CCT ADJUSTABLE DOWNLIGHT

Project: _____ Type: _____

Name: _____ Date: _____

DIMENSIONS:

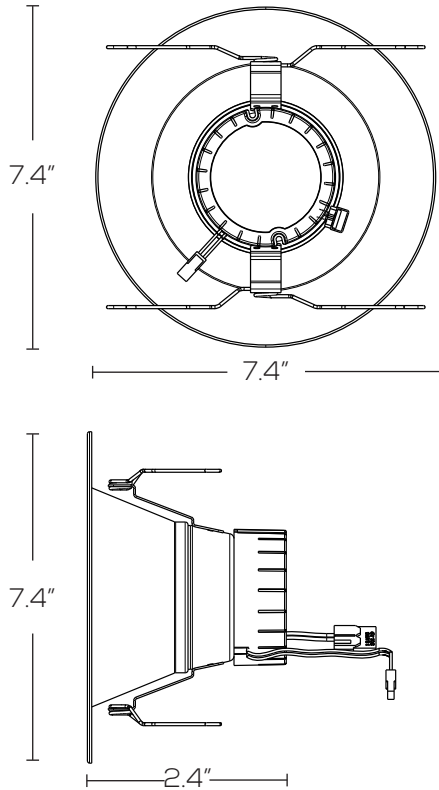

PHOTOMETRICS:

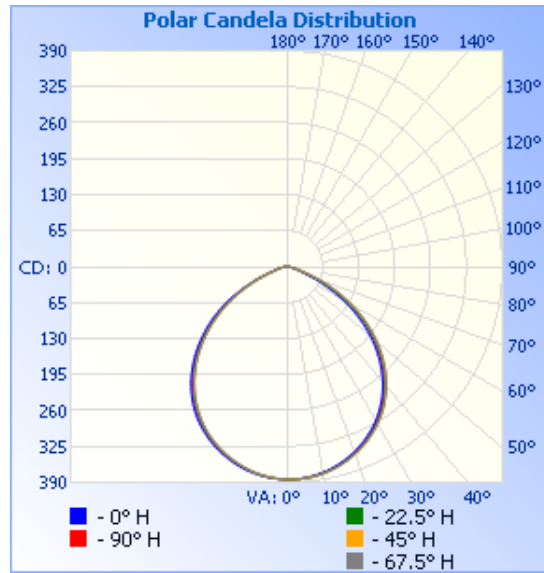

	Center Beam fc	Beam Width	
1.7ft	133 fc	4.2 ft	4.2 ft
3.3ft	35.3 fc	8.2 ft	8.2 ft
5.0ft	15.4 fc	12.4 ft	12.5 ft
6.7ft	8.56 fc	16.6 ft	16.7 ft
8.3ft	5.58 fc	20.5 ft	20.7 ft
10.0ft	3.84 fc	24.7 ft	24.9 ft

■ Vert. Spread: 102.1°
■ Horiz. Spread: 102.5°

WARNING:

1. Risk of fire or electric shock. LED Adjustable CCT Downlight installation requires knowledge of lighting electrical systems. If not qualified contact a certified electrician for installation.
2. Install this kit only in luminaires that have the construction features and dimensions shown in the drawings and where the input rating of the retrofit kit does not exceed the voltage rating of the luminaire.
3. Do not make or alter any open holes in an enclosure of wiring or electrical components during kit installation.
4. To prevent damage or abrasion, do not expose wiring to edges of sheet metal or other sharp objects.
5. This luminaire has been built to operate LED lamps. Do not attempt to install fluorescent lamps in this light.



DL4 AND DL6 CCT ADJUSTABLE DOWNLIGHT

Project: _____ Type: _____

Name: _____ Date: _____

INSTALLATION:

1. Remove the existing lamps and trim.
2. Screw E26 Connector plug into the existing socket.
3. Select desired color temperature on top of the fixture.
4. Connect the terminals from E26 socket to fixture.
5. Press spring clips together, push fixture up into existing recessed hole/cylinder and release once in, then continue until it's flush with ceiling.

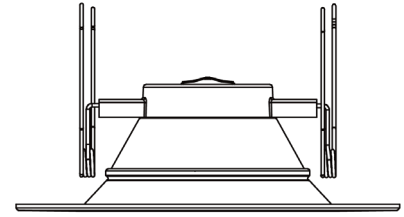

Step 1

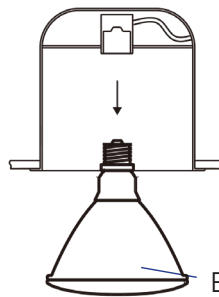

Existing Lamp

Step 2

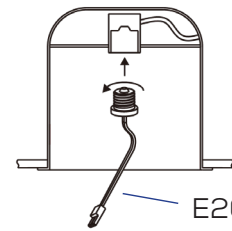

E26 Connector

REMOVAL:

- With your fingertips, pull down firmly on the trim ring until fixture stops.
- Squeeze torsion springs together to remove LED fixture.
- Disconnect Fixture from socket adapter.
- Unscrew socket adapter (E26) from recessed hole/cylinder.

Step 3

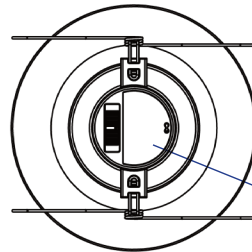

CCT Switch

Step 4

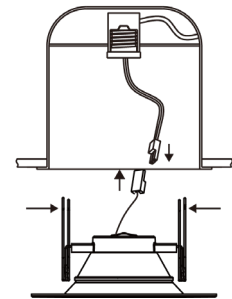

CCT SELECTOR SWITCH:

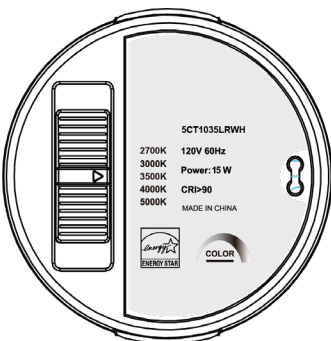

The CCT tunable selector switch located on top of the fixture allows the user to choose between 2700K, 3000K, 3500K, 4000K and 5000K.

Step 5

