



2X2 SURFACE MOUNT KIT

Project: _____ Type: _____

Name: _____ Date: _____

IMPORTANT: Install by Qualified Electrician. Please read instructions before proceeding with installation. Keep these instructions for future reference.

WARNING

RISK OF ELECTRIC SHOCK

- Turn off power prior to inspection, installation or removal of fixture.
- Ensure electrical enclosure is properly grounded in accordance with National Electrical Code (NEC).

RISK OF FIRE

- Product must be installed in accordance with NEC and/or applicable local codes by a qualified licensed electrician.
- Wiring connections should be made with UL approved wire connectors.

THIS PRODUCT MUST BE INSTALLED IN ACCORDANCE WITH THE APPLICABLE INSTALLATION CODE BY A PERSON FAMILIAR WITH THE CONSTRUCTION AND OPERATION OF THE PRODUCT AND THE HAZARDS INVOLVED

ATTENTION

- Do not disassemble fixture. No user or serviceable parts inside.
- Use care when handling the luminaire. Do not drop, press, or bend the light panel to avoid damage during installation.
- Work gloves are recommended when handling the LED flat panel to protect hands and prevent the transfer of dirt and oil to the luminaire.
- Prior to installation, carefully unpack and properly inspect luminaire for any damage or loose connections that may have occurred during shipping.

SPECIFICATIONS

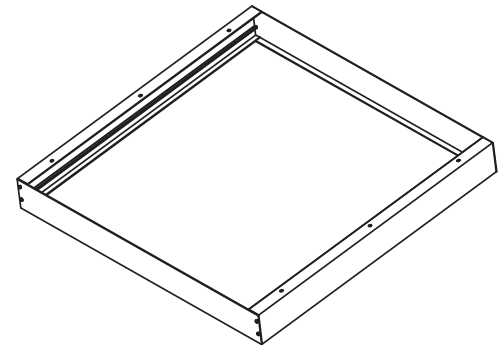
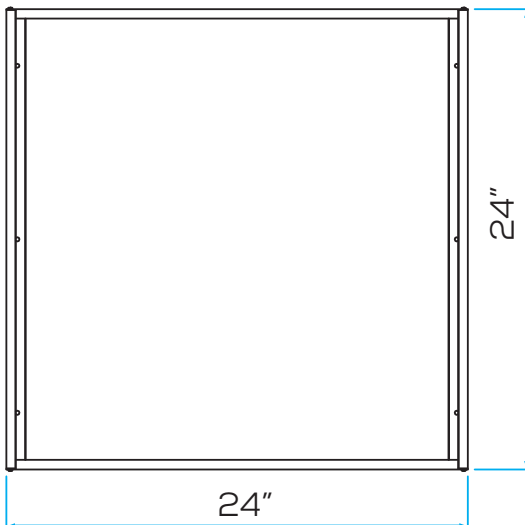



2X2 SURFACE MOUNT KIT

Project: _____ Type: _____

Name: _____ Date: _____

Surface Mount Installation Steps

The fixture is suitable only for INDOOR SURFACE CEILING application. To mount on an insulated or non-insulated sheet rock ceiling, follow the steps below:

Step 1: Open the Packing and take out the two frame ends and two side rails (**IMAGE 1**)

Step 2: Assemble the frame using the ends to form a rectangle. (**IMAGE 2 & 3**)

Step 3: With the aid of a helper, temporarily place the assembled frame against the mounting surface where the frame will be permanently mounted. Frame must be squared. Mark the location of the mounting holes in the frame. Set frame aside.

Step 4: Secure the frame to ceiling, with appropriate mounting hardware suitable for the mounting surface as per NEC and local codes, to support the minimum weight of 50 lbs. Install the appropriate mounting hardware that will hold the fixture and frame to the surface.

Step 5: Remove cover of wiring compartment on the fixture.

Step 6: With the frame securely mounted to the mounting surface, remove one of the frame ends. Slide the LED fixture halfway into the mounted frame, maintaining access to the wiring compartment. (**IMAGE 4**)

Step 7: Make the electrical connections to the fixture, following the wiring instructions that were provided with the fixture. Once electrical connections are complete, reattach the cover of the wiring compartment.

Step 8: Push the fixture all the way into the frame and reattach the frame end removed earlier. (**IMAGE 5**)

Step 9: Turn the power back on

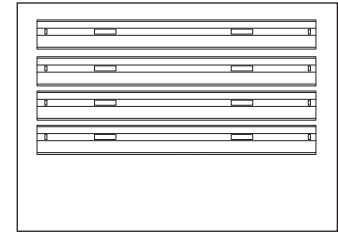

IMAGE 1

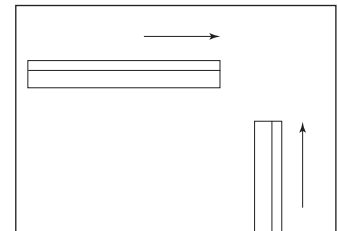

IMAGE 2

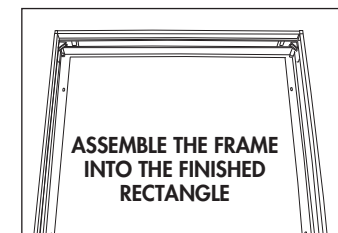

IMAGE 3

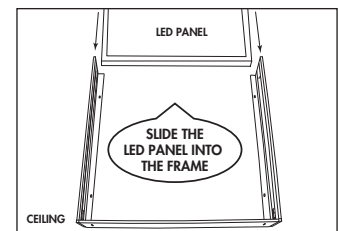

IMAGE 4

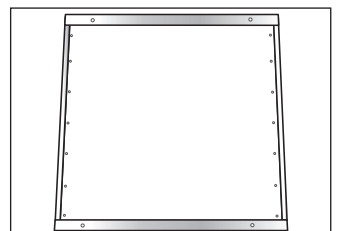

IMAGE 5