



SB16

SHOEBOX LIGHT

Project: _____ Type: _____

Name: _____ Date: _____



| Watts | 300W | 450W |
|------------|---------------------|-------------------|
| Lumens | 43,200-45,300lm | 58,500-65,250lm |
| Size | See Dimensions | |
| Voltage | 120-277V | |
| Dimming | 0-10V | |
| Beam Angle | 155*90° Type III | |
| CRI | >80 | |
| PF | ≥ 0.9 | |
| | | CCT |
| | | 5700K |
| | | IP Rating |
| | | IP65 |
| | | Materials |
| | | Die-Cast Aluminum |
| | | Finish |
| | | Bronze |
| | | Lens |
| | | Clear |
| | | Lifespan |
| | | 50,000 Hours |

OVERVIEW

- CCT:** Tunable, 5700K
- Applications:** IP65
- Efficacy:** 135-155lm/W
- Dimming:** 0-10V
- LED Type:** Lumileds 2835
- Lens Type:** Clear
- Operating Temp:** -13°F to 113°F
- Operating Humidity:** 5% - 95% RH
- Lifespan:** 50,000 Hours
- Warranty:** 5 Years

FEATURES

- 10KV Surge Protector pre-installed
- Included Slipfitter Mount
- Optional Accessories: Photocell, Surge protector, Shield, Motion Sensor

SARIN LED Shoebox Lights are commonly used to replace high-pressure sodium and metal halide lights to provide energy savings of up to 70%. These area lights are safe for outdoor use and are protected from rain, snow, and weak jets of water, such as sprinklers. These versions come with a pre-installed slipfitter mount, making installation even easier!

Shoebox Lights are perfect for stadiums, parks, billboards, parking lots, and office buildings. An optional photocell sensor allows the light to automatically activate at night. The lens has a glare-reduction composition that softens the light and makes it more uniform and safe to the eye. This Dark Sky compliant light eliminates glare and prevents light pollution.*



*Dark Sky compliance at 3000K





SB16

SHOEBOX LIGHT

Project: _____ Type: _____

Name: _____ Date: _____

PHOTOMETRICS:

300W

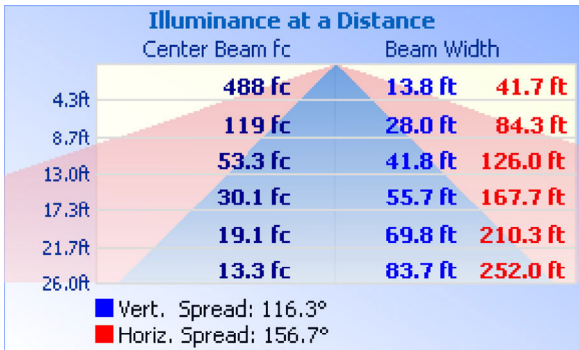
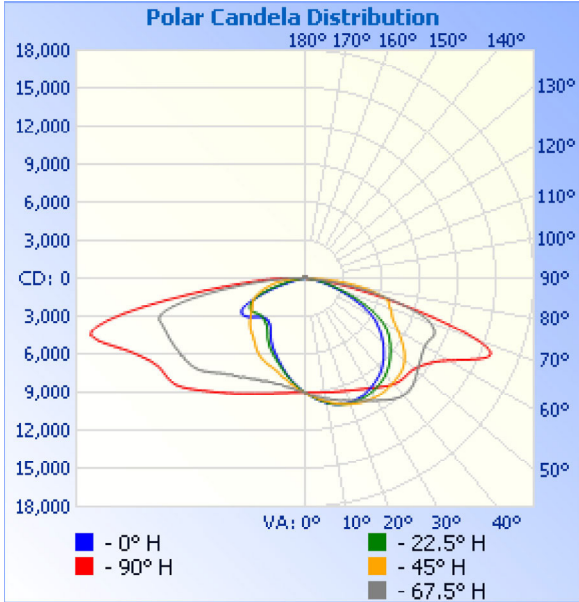

450W

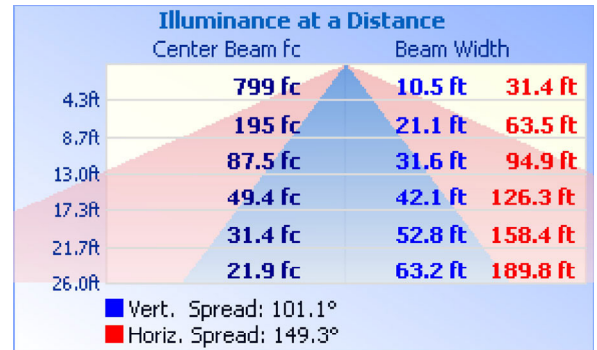
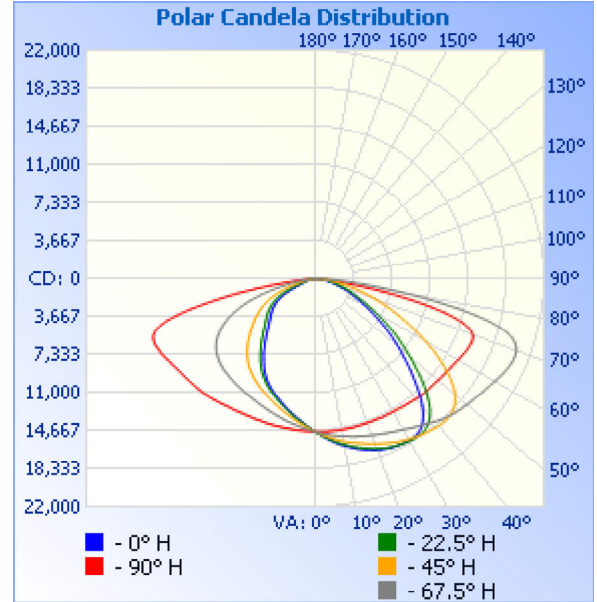



SB16

**SHOEBOX
LIGHT**

Project: _____ Type: _____

Name: _____ Date: _____

DIMENSIONS:

300W

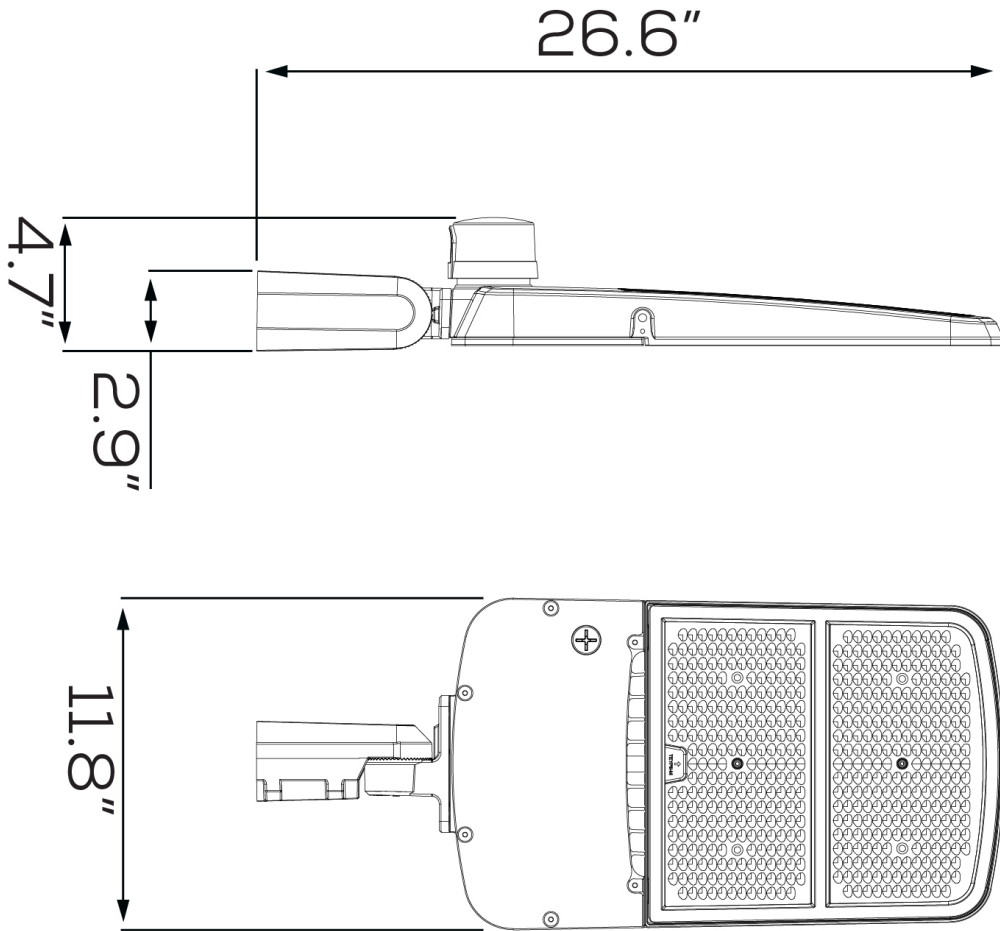



SB16

SHOEBOX
LIGHT

Project: _____ Type: _____

Name: _____ Date: _____

DIMENSIONS:

450W

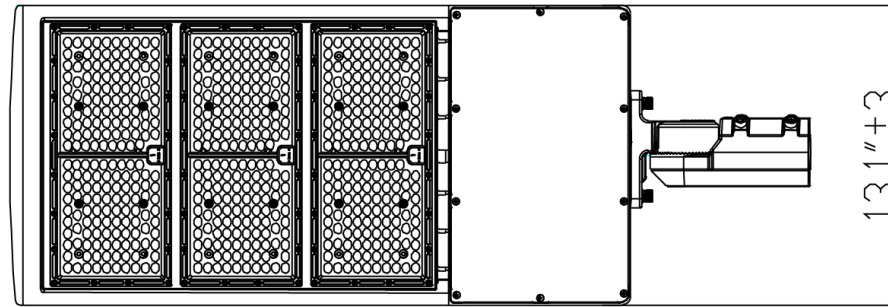
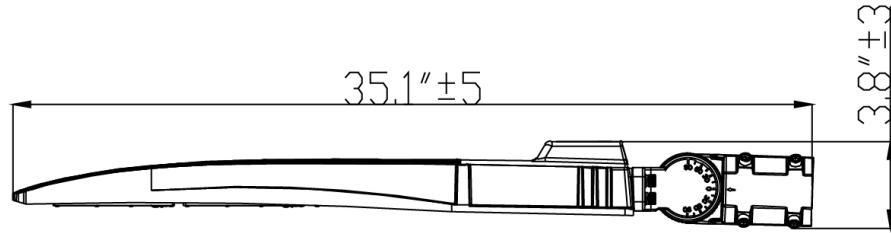



SB16

SHOEBOX LIGHT

Project: _____ Type: _____

Name: _____ Date: _____

ORDER FORM:

(*) Special Order/Not Commonly Stocked

Custom Model Assembly

| | | | | |
|--|---|--|--|--|
| Fixture | CCT | Watts | Beam Angle | Voltage |
| <input checked="" type="checkbox"/> SB16 | <input checked="" type="checkbox"/> 5700K | <input type="checkbox"/> 300W <input type="checkbox"/> 450W | <input checked="" type="checkbox"/> Type III | <input checked="" type="checkbox"/> 120-277V |

SES-SB16-CCT-150W
Example Model Number

SES – SB16 – 5700K – Type III – 120-277

Quantity

Fixture

CCT

Watts

Beam Angle

Voltage

Common Stock Models:

Optional Accessories:

| Item # | Model # |
|---------|----------------------|
| 11480 | SES-SB16-5700-300-SF |
| 11369-S | SES-SB16-5700-450-SF |

| Item # | Model # | QTY: |
|---------|----------------------|------|
| 11415 | SES-SB16-PHOTOCELL | |
| 11325-K | SB16-TYPE4-300W-LENS | |
| 11325-L | SB16-TYPE5-300W-LENS | |



Photocell



Lens